

JEE-2008
Paper I

1. Consider the two curves

$$C_1 : y^2 = 4x$$

$$C_2 : x^2 + y^2 - 6x + 1 = 0$$

Then,

- (A) C_1 and C_2 touch each other only at one point
 (B) C_1 and C_2 touch each other exactly at two points
 (C) C_1 and C_2 intersect (but do not touch) at exactly two points
 (D) C_1 and C_2 neither intersect nor touch each other

Answer

- (A) (B) (C) (D)

2. If $0 < x < 1$, then

$$\sqrt{1+x^2} [\{x \cos(\cot^{-1} x) + \sin(\cot^{-1} x)\}^2 - 1]^{\frac{1}{2}} =$$

- (A) $\frac{x}{\sqrt{1+x^2}}$ (B) x (C) $x\sqrt{1+x^2}$ (D) $\sqrt{1+x^2}$

Answer

- (A) (B) (C) (D)

3. The edges of a parallelepiped are of unit length and are parallel to non-coplanar unit vectors $\hat{a}, \hat{b}, \hat{c}$ such that

$$\hat{a} \cdot \hat{b} = \hat{b} \cdot \hat{c} = \hat{c} \cdot \hat{a} = \frac{1}{2}$$

Then, the volume of the parallelepiped is

- (A) $\frac{1}{\sqrt{2}}$ (B) $\frac{1}{2\sqrt{2}}$ (C) $\frac{\sqrt{3}}{2}$ (D) $\frac{1}{\sqrt{3}}$

Answer

- (A) (B) (C) (D)

4. Let a and b be non-zero real numbers. Then, the equation

$$(ax^2 + by^2 + c)(x^2 - 5xy + 6y^2) = 0$$

represents

- (A) four straight lines, when $c = 0$ and a, b are of the same sign
 (B) two straight lines and a circle, when $a = b$, and c is of sign opposite to that of a
 (C) two straight lines and a hyperbola, when a and b are of the same sign and c is of sign opposite to that of a
 (D) a circle and an ellipse, when a and b are of the same sign and c is of sign opposite to that of a

Answer

- (A) (B) (C) (D)

5. Let

$$g(x) = \frac{(x-1)^n}{\log \cos^m(x-1)}; \quad 0 < x < 2, \quad m \text{ and } n \text{ are integers, } m \neq 0, \quad n > 0, \text{ and}$$

let p be the left hand derivative of $|x-1|$ at $x=1$.

If $\lim_{x \rightarrow 1^+} g(x) = p$, then

(A) $n = 1, m = 1$

(B) $n = 1, m = -1$

(C) $n = 2, m = 2$

(D) $n > 2, m = n$

Answer

- (A)
 (B)
 (C)
 (D)

6. The total number of local maxima and local minima of the function

$$f(x) = \begin{cases} (2+x)^3, & -3 < x \leq -1 \\ x^{2/3}, & -1 < x < 2 \end{cases}$$

is

(A) 0

(B) 1

(C) 2

(D) 3

Answer

- (A)
 (B)
 (C)
 (D)

7. A straight line through the vertex P of a triangle PQR intersects the side QR at the point S and the circumcircle of the triangle PQR at the point T . If S is not the centre of the circumcircle, then

(A) $\frac{1}{PS} + \frac{1}{ST} < \frac{2}{\sqrt{QS \times SR}}$

(B) $\frac{1}{PS} + \frac{1}{ST} > \frac{2}{\sqrt{QS \times SR}}$

(C) $\frac{1}{PS} + \frac{1}{ST} < \frac{4}{QR}$

(D) $\frac{1}{PS} + \frac{1}{ST} > \frac{4}{QR}$

Answer

- (A)
 (B)
 (C)
 (D)

8. Let $P(x_1, y_1)$ and $Q(x_2, y_2)$, $y_1 < 0$, $y_2 < 0$, be the end points of the latus rectum of the ellipse $x^2 + 4y^2 = 4$. The equations of parabolas with latus rectum PQ are

- (A) $x^2 + 2\sqrt{3}y = 3 + \sqrt{3}$
 (B) $x^2 - 2\sqrt{3}y = 3 + \sqrt{3}$
 (C) $x^2 + 2\sqrt{3}y = 3 - \sqrt{3}$
 (D) $x^2 - 2\sqrt{3}y = 3 - \sqrt{3}$

Answer

- (A) (B) (C) (D)

9. Let

$$S_n = \sum_{k=1}^n \frac{n}{n^2 + kn + k^2} \quad \text{and} \quad T_n = \sum_{k=0}^{n-1} \frac{n}{n^2 + kn + k^2},$$

for $n = 1, 2, 3, \dots$. Then,

- (A) $S_n < \frac{\pi}{3\sqrt{3}}$ (B) $S_n > \frac{\pi}{3\sqrt{3}}$
 (C) $T_n < \frac{\pi}{3\sqrt{3}}$ (D) $T_n > \frac{\pi}{3\sqrt{3}}$

Answer

- (A) (B) (C) (D)

10. Let $f(x)$ be a non-constant twice differentiable function defined on $(-\infty, \infty)$ such that $f(x) = f(1-x)$ and $f'\left(\frac{1}{4}\right) = 0$. Then,

- (A) $f''(x)$ vanishes at least twice on $[0, 1]$
 (B) $f'\left(\frac{1}{2}\right) = 0$
 (C) $\int_{-1/2}^{1/2} f\left(x + \frac{1}{2}\right) \sin x \, dx = 0$
 (D) $\int_0^{1/2} f(t) e^{\sin \pi t} \, dt = \int_{1/2}^1 f(1-t) e^{\sin \pi t} \, dt$

Answer

- (A) (B) (C) (D)

11. Let f and g be real valued functions defined on interval $(-1, 1)$ such that $g''(x)$ is continuous, $g(0) \neq 0$, $g'(0) = 0$, $g''(0) \neq 0$, and $f(x) = g(x)\sin x$.

$$\text{STATEMENT-1: } \lim_{x \rightarrow 0} [g(x)\cot x - g(0)\operatorname{cosec} x] = f''(0).$$

and

$$\text{STATEMENT-2: } f'(0) = g(0).$$

- (A) STATEMENT-1 is True, STATEMENT-2 is True; STATEMENT-2 is a correct explanation for STATEMENT-1
- (B) STATEMENT-1 is True, STATEMENT-2 is True; STATEMENT-2 is **NOT** a correct explanation for STATEMENT-1
- (C) STATEMENT-1 is True, STATEMENT-2 is False
- (D) STATEMENT-1 is False, STATEMENT-2 is True

Answer

- (A) (B) (C) (D)

12. Consider three planes

$$P_1 : x - y + z = 1$$

$$P_2 : x + y - z = -1$$

$$P_3 : x - 3y + 3z = 2.$$

Let L_1, L_2, L_3 be the lines of intersection of the planes P_2 and P_3 , P_3 and P_1 , and P_1 and P_2 , respectively.

STATEMENT-1 : At least two of the lines L_1, L_2 and L_3 are non-parallel.

and

STATEMENT-2 : The three planes do not have a common point.

- (A) STATEMENT-1 is True, STATEMENT-2 is True; STATEMENT-2 is a correct explanation for STATEMENT-1
- (B) STATEMENT-1 is True, STATEMENT-2 is True; STATEMENT-2 is **NOT** a correct explanation for STATEMENT-1
- (C) STATEMENT-1 is True, STATEMENT-2 is False
- (D) STATEMENT-1 is False, STATEMENT-2 is True

Answer

- (A) (B) (C) (D)

13. Consider the system of equations

$$x - 2y + 3z = -1$$

$$-x + y - 2z = k$$

$$x - 3y + 4z = 1.$$

STATEMENT-1 : The system of equations has no solution for $k \neq 3$.

and

STATEMENT-2 : The determinant $\begin{vmatrix} 1 & 3 & -1 \\ -1 & -2 & k \\ 1 & 4 & 1 \end{vmatrix} \neq 0$, for $k \neq 3$.

- (A) STATEMENT-1 is True, STATEMENT-2 is True; STATEMENT-2 is a correct explanation for STATEMENT-1
- (B) STATEMENT-1 is True, STATEMENT-2 is True; STATEMENT-2 is **NOT** a correct explanation for STATEMENT-1
- (C) STATEMENT-1 is True, STATEMENT-2 is False
- (D) STATEMENT-1 is False, STATEMENT-2 is True

Answer



(A)



(B)



(C)



(D)

14. Consider the system of equations

$$ax + by = 0, cx + dy = 0, \text{ where } a, b, c, d \in \{0, 1\} .$$

STATEMENT-1 : The probability that the system of equations has a unique solution is $\frac{3}{8}$.

and

STATEMENT-2 : The probability that the system of equations has a solution is 1 .

- (A) STATEMENT-1 is True, STATEMENT-2 is True; STATEMENT-2 is a correct explanation for STATEMENT-1
- (B) STATEMENT-1 is True, STATEMENT-2 is True; STATEMENT-2 is **NOT** a correct explanation for STATEMENT-1
- (C) STATEMENT-1 is True, STATEMENT-2 is False
- (D) STATEMENT-1 is False, STATEMENT-2 is True

Answer



(A)



(B)



(C)



(D)

Paragraph for Question Nos. 15 to 17

A circle C of radius 1 is inscribed in an equilateral triangle PQR . The points of contact of C with the sides PQ , QR , RP are D , E , F , respectively. The line PQ is given by the equation $\sqrt{3}x + y - 6 = 0$ and the point D is $\left(\frac{3\sqrt{3}}{2}, \frac{3}{2}\right)$. Further, it is given that the origin and the centre of C are on the same side of the line PQ .

15. The equation of circle C is

(A) $(x - 2\sqrt{3})^2 + (y - 1)^2 = 1$

(B) $(x - 2\sqrt{3})^2 + (y + \frac{1}{2})^2 = 1$

(C) $(x - \sqrt{3})^2 + (y + 1)^2 = 1$

(D) $(x - \sqrt{3})^2 + (y - 1)^2 = 1$

Answer

- (A) (B) (C) (D)

16. Points E and F are given by

(A) $\left(\frac{\sqrt{3}}{2}, \frac{3}{2}\right), (\sqrt{3}, 0)$

(B) $\left(\frac{\sqrt{3}}{2}, \frac{1}{2}\right), (\sqrt{3}, 0)$

(C) $\left(\frac{\sqrt{3}}{2}, \frac{3}{2}\right), \left(\frac{\sqrt{3}}{2}, \frac{1}{2}\right)$

(D) $\left(\frac{3}{2}, \frac{\sqrt{3}}{2}\right), \left(\frac{\sqrt{3}}{2}, \frac{1}{2}\right)$

Answer

- (A) (B) (C) (D)

17. Equations of the sides QR , RP are

(A) $y = \frac{2}{\sqrt{3}}x + 1, y = -\frac{2}{\sqrt{3}}x - 1$

(B) $y = \frac{1}{\sqrt{3}}x, y = 0$

(C) $y = \frac{\sqrt{3}}{2}x + 1, y = -\frac{\sqrt{3}}{2}x - 1$

(D) $y = \sqrt{3}x, y = 0$

Answer

- (A) (B) (C) (D)

Paragraph for Question Nos. 18 to 20

Consider the functions defined implicitly by the equation $y^3 - 3y + x = 0$ on various intervals in the real line.

If $x \in (-\infty, -2) \cup (2, \infty)$, the equation implicitly defines a unique real valued differentiable function $y = f(x)$.

If $x \in (-2, 2)$, the equation implicitly defines a unique real valued differentiable function $y = g(x)$ satisfying $g(0) = 0$.

18. If $f(-10\sqrt{2}) = 2\sqrt{2}$, then $f''(-10\sqrt{2}) =$

(A) $\frac{4\sqrt{2}}{7^3 3^2}$

(B) $-\frac{4\sqrt{2}}{7^3 3^2}$

(C) $\frac{4\sqrt{2}}{7^3 3}$

(D) $-\frac{4\sqrt{2}}{7^3 3}$

Answer

- (A) (B) (C) (D)

19. The area of the region bounded by the curve $y = f(x)$, the x -axis, and the lines $x = a$ and $x = b$, where $-\infty < a < b < -2$, is

- (A) $\int_a^b \frac{x}{3((f(x))^2 - 1)} dx + bf(b) - af(a)$
 (B) $-\int_a^b \frac{x}{3((f(x))^2 - 1)} dx + bf(b) - af(a)$
 (C) $\int_a^b \frac{x}{3((f(x))^2 - 1)} dx - bf(b) + af(a)$
 (D) $-\int_a^b \frac{x}{3((f(x))^2 - 1)} dx - bf(b) + af(a)$

Answer

- (A) (B) (C) (D)

20. $\int_{-1}^1 g'(x) dx =$
 (A) $2g(-1)$ (B) 0 (C) $-2g(1)$ (D) $2g(1)$

Answer

- (A) (B) (C) (D)

Paragraph for Question Nos. 21 to 23

Let A, B, C be three sets of complex numbers as defined below

$$A = \{z : \text{Im } z \geq 1\}$$

$$B = \{z : |z - 2 - i| = 3\}$$

$$C = \{z : \text{Re}((1 - i)z) = \sqrt{2}\}.$$

21. The number of elements in the set $A \cap B \cap C$ is
 (A) 0 (B) 1 (C) 2 (D) ∞

Answer

- (A) (B) (C) (D)

22. Let z be any point in $A \cap B \cap C$. Then, $|z + 1 - i|^2 + |z - 5 - i|^2$ lies between
 (A) 25 and 29 (B) 30 and 34 (C) 35 and 39 (D) 40 and 44

Answer

- (A) (B) (C) (D)

23. Let z be any point in $A \cap B \cap C$ and let w be any point satisfying $|w - 2 - i| < 3$. Then, $|z| - |w| + 3$ lies between
- (A) -6 and 3 (B) -3 and 6 (C) -6 and 6 (D) -3 and 9

(A) (B) (C) (D)

OR

Answer (A) (B) (C) (D)

OR

(A) (B) (C) (D)

24. Students I, II and III perform an experiment for measuring the acceleration due to gravity (g) using a simple pendulum. They use different lengths of the pendulum and/or record time for different number of oscillations. The observations are shown in the table.

Least count for length = 0.1 cm

Least count for time = 0.1 s

Student	Length of the pendulum (cm)	Number of oscillations (n)	Total time for (n) oscillations (s)	Time period (s)
I	64.0	8	128.0	16.0
II	64.0	4	64.0	16.0
III	20.0	4	36.0	9.0

If E_I , E_{II} and E_{III} are the percentage errors in g , i.e., $\left(\frac{\Delta g}{g} \times 100\right)$ for students I, II and III, respectively,

- (A) $E_I = 0$ (B) E_I is minimum
 (C) $E_I = E_{II}$ (D) E_{II} is maximum

Answer (A) (B) (C) (D)

25. Figure shows three resistor configurations R1, R2 and R3 connected to 3 V battery. If the power dissipated by the configuration R1, R2 and R3 is P1, P2 and P3, respectively, then

Figure :

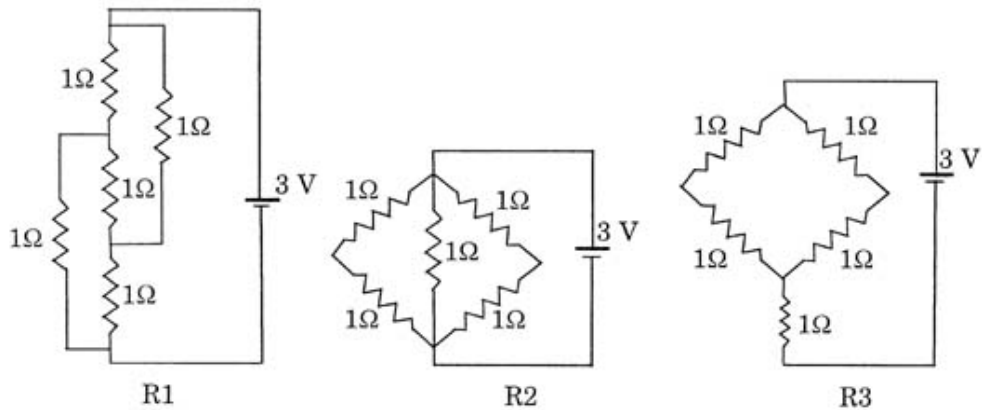

- (A) $P_1 > P_2 > P_3$ (B) $P_1 > P_3 > P_2$
 (C) $P_2 > P_1 > P_3$ (D) $P_3 > P_2 > P_1$

Answer (A) (B) (C) (D)

26. Which one of the following statements is **WRONG** in the context of X-rays generated from a X-ray tube?

- (A) Wavelength of characteristic X-rays decreases when the atomic number of the target increases
 (B) Cut-off wavelength of the continuous X-rays depends on the atomic number of the target
 (C) Intensity of the characteristic X-rays depends on the electrical power given to the X-ray tube
 (D) Cut-off wavelength of the continuous X-rays depends on the energy of the electrons in the X-ray tube

Answer (A) (B) (C) (D)

27. Two beams of red and violet colours are made to pass separately through a prism (angle of the prism is 60°). In the position of minimum deviation, the angle of refraction will be

- (A) 30° for both the colours (B) greater for the violet colour
 (C) greater for the red colour (D) equal but not 30° for both the colours

Answer (A) (B) (C) (D)

28. An ideal gas is expanding such that $PT^2 = \text{constant}$. The coefficient of volume expansion of the gas is
- (A) $\frac{1}{T}$ (B) $\frac{2}{T}$ (C) $\frac{3}{T}$ (D) $\frac{4}{T}$

Answer (A) (B) (C) (D)

29. A spherically symmetric gravitational system of particles has a mass density
- $$\rho = \begin{cases} \rho_0 & \text{for } r \leq R \\ 0 & \text{for } r > R \end{cases}$$

where ρ_0 is a constant. A test mass can undergo circular motion under the influence of the gravitational field of particles. Its speed V as a function of distance r ($0 < r < \infty$) from the centre of the system is represented by

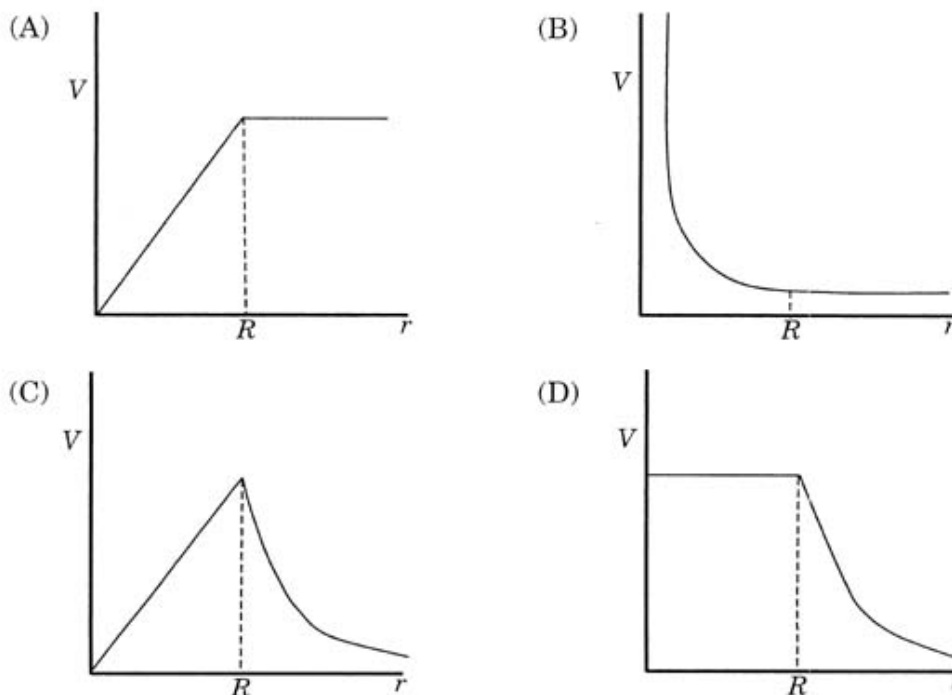

Answer (A) (B) (C) (D)

30. Two balls, having linear momenta $\vec{p}_1 = p\hat{i}$ and $\vec{p}_2 = -p\hat{i}$, undergo a collision in free space. There is no external force acting on the balls. Let \vec{p}'_1 and \vec{p}'_2 be their final momenta. The following option(s) is(are) **NOT ALLOWED** for any non-zero value of $p, a_1, a_2, b_1, b_2, c_1$ and c_2 .

- (A) $\vec{p}'_1 = a_1\hat{i} + b_1\hat{j} + c_1\hat{k}$ (B) $\vec{p}'_1 = c_1\hat{k}$
 $\vec{p}'_2 = a_2\hat{i} + b_2\hat{j}$ $\vec{p}'_2 = c_2\hat{k}$
- (C) $\vec{p}'_1 = a_1\hat{i} + b_1\hat{j} + c_1\hat{k}$ (D) $\vec{p}'_1 = a_1\hat{i} + b_1\hat{j}$
 $\vec{p}'_2 = a_2\hat{i} + b_2\hat{j} - c_1\hat{k}$ $\vec{p}'_2 = a_2\hat{i} + b_1\hat{j}$

Answer (A) (B) (C) (D)

31. Assume that the nuclear binding energy per nucleon (B/A) versus mass number (A) is as shown in the figure. Use this plot to choose the correct choice(s) given below.

Figure :

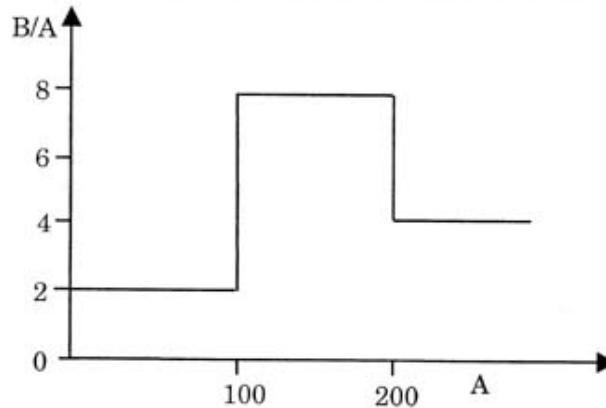

- (A) Fusion of two nuclei with mass numbers lying in the range of $1 < A < 50$ will release energy
 (B) Fusion of two nuclei with mass numbers lying in the range of $51 < A < 100$ will release energy
 (C) Fission of a nucleus lying in the mass range of $100 < A < 200$ will release energy when broken into two equal fragments
 (D) Fission of a nucleus lying in the mass range of $200 < A < 260$ will release energy when broken into two equal fragments

Answer

- (A) (B) (C) (D)

32. A particle of mass m and charge q , moving with velocity V enters Region II normal to the boundary as shown in the figure. Region II has a uniform magnetic field B perpendicular to the plane of the paper. The length of the Region II is ℓ . Choose the correct choice(s).

Figure :

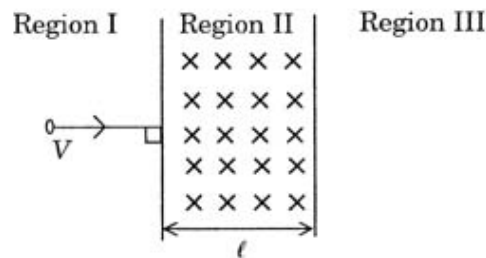

- (A) The particle enters Region III only if its velocity $V > \frac{q\ell B}{m}$
 (B) The particle enters Region III only if its velocity $V < \frac{q\ell B}{m}$
 (C) Path length of the particle in Region II is maximum when velocity $V = \frac{q\ell B}{m}$
 (D) Time spent in Region II is same for any velocity V as long as the particle returns to Region I

Answer

- (A) (B) (C) (D)

33. In a Young's double slit experiment, the separation between the two slits is d and the wavelength of the light is λ . The intensity of light falling on slit 1 is four times the intensity of light falling on slit 2. Choose the correct choice(s).
- (A) If $d = \lambda$, the screen will contain only one maximum
- (B) If $\lambda < d < 2\lambda$, at least one more maximum (besides the central maximum) will be observed on the screen
- (C) If the intensity of light falling on slit 1 is reduced so that it becomes equal to that of slit 2, the intensities of the observed dark and bright fringes will increase
- (D) If the intensity of light falling on slit 2 is increased so that it becomes equal to that of slit 1, the intensities of the observed dark and bright fringes will increase

Answer

- (A) (B) (C) (D)

34. STATEMENT-1

In a Meter Bridge experiment, null point for an unknown resistance is measured. Now, the unknown resistance is put inside an enclosure maintained at a higher temperature. The null point can be obtained at the same point as before by decreasing the value of the standard resistance.

and

STATEMENT-2

Resistance of a metal increases with increase in temperature.

- (A) STATEMENT-1 is True, STATEMENT-2 is True; STATEMENT-2 is a correct explanation for STATEMENT-1
- (B) STATEMENT-1 is True, STATEMENT-2 is True; STATEMENT-2 is **NOT** a correct explanation for STATEMENT-1
- (C) STATEMENT-1 is True, STATEMENT-2 is False
- (D) STATEMENT-1 is False, STATEMENT-2 is True

Answer

- (A) (B) (C) (D)

35. STATEMENT-1

An astronaut in an orbiting space station above the Earth experiences weightlessness.

and

STATEMENT-2

An object moving around the Earth under the influence of Earth's gravitational force is in a state of 'free-fall'.

- (A) STATEMENT-1 is True, STATEMENT-2 is True; STATEMENT-2 is a correct explanation for STATEMENT-1
- (B) STATEMENT-1 is True, STATEMENT-2 is True; STATEMENT-2 is **NOT** a correct explanation for STATEMENT-1
- (C) STATEMENT-1 is True, STATEMENT-2 is False
- (D) STATEMENT-1 is False, STATEMENT-2 is True

Answer

- (A) (B) (C) (D)

36. STATEMENT-1

Two cylinders, one hollow (metal) and the other solid (wood) with the same mass and identical dimensions are simultaneously allowed to roll without slipping down an inclined plane from the same height. The hollow cylinder will reach the bottom of the inclined plane first.

and

STATEMENT-2

By the principle of conservation of energy, the total kinetic energies of both the cylinders are identical when they reach the bottom of the incline.

- (A) STATEMENT-1 is True, STATEMENT-2 is True; STATEMENT-2 is a correct explanation for STATEMENT-1
- (B) STATEMENT-1 is True, STATEMENT-2 is True; STATEMENT-2 is **NOT** a correct explanation for STATEMENT-1
- (C) STATEMENT-1 is True, STATEMENT-2 is False
- (D) STATEMENT-1 is False, STATEMENT-2 is True

Answer

- (A) (B) (C) (D)

37. STATEMENT-1

The stream of water flowing at high speed from a garden hose pipe tends to spread like a fountain when held vertically up, but tends to narrow down when held vertically down.

and

STATEMENT-2

In any steady flow of an incompressible fluid, the volume flow rate of the fluid remains constant.

- (A) STATEMENT-1 is True, STATEMENT-2 is True; STATEMENT-2 is a correct explanation for STATEMENT-1
- (B) STATEMENT-1 is True, STATEMENT-2 is True; STATEMENT-2 is **NOT** a correct explanation for STATEMENT-1
- (C) STATEMENT-1 is True, STATEMENT-2 is False
- (D) STATEMENT-1 is False, STATEMENT-2 is True

Answer

- (A) (B) (C) (D)

Paragraph for Question Nos. 38 to 40

A small spherical monoatomic ideal gas bubble ($\gamma = \frac{5}{3}$) is trapped inside a liquid of density ρ_l (see figure). Assume that the bubble does not exchange any heat with the liquid. The bubble contains n moles of gas. The temperature of the gas when the bubble is at the bottom is T_0 , the height of the liquid is H and the atmospheric pressure is P_0 (Neglect surface tension).

Figure :

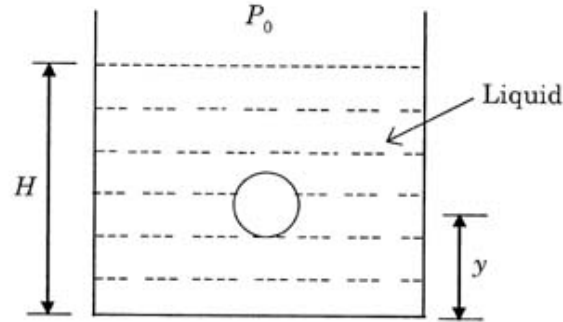

38. As the bubble moves upwards, besides the buoyancy force the following forces are acting on it
- (A) Only the force of gravity
 - (B) The force due to gravity and the force due to the pressure of the liquid
 - (C) The force due to gravity, the force due to the pressure of the liquid and the force due to viscosity of the liquid
 - (D) The force due to gravity and the force due to viscosity of the liquid

Answer

- (A) (B) (C) (D)

39. When the gas bubble is at a height y from the bottom, its temperature is

- (A) $T_0 \left(\frac{P_0 + \rho_l g H}{P_0 + \rho_l g y} \right)^{2/5}$
- (B) $T_0 \left(\frac{P_0 + \rho_l g (H - y)}{P_0 + \rho_l g H} \right)^{2/5}$
- (C) $T_0 \left(\frac{P_0 + \rho_l g H}{P_0 + \rho_l g y} \right)^{3/5}$
- (D) $T_0 \left(\frac{P_0 + \rho_l g (H - y)}{P_0 + \rho_l g H} \right)^{3/5}$

Answer

- (A) (B) (C) (D)

40. The buoyancy force acting on the gas bubble is (Assume R is the universal gas constant)

(A) $\rho_l n R g T_0 \frac{(P_0 + \rho_l g H)^{2/5}}{(P_0 + \rho_l g y)^{7/5}}$

(B) $\frac{\rho_l n R g T_0}{(P_0 + \rho_l g H)^{2/5} [P_0 + \rho_l g (H - y)]^{3/5}}$

(C) $\rho_l n R g T_0 \frac{(P_0 + \rho_l g H)^{3/5}}{(P_0 + \rho_l g y)^{8/5}}$

(D) $\frac{\rho_l n R g T_0}{(P_0 + \rho_l g H)^{3/5} [P_0 + \rho_l g (H - y)]^{2/5}}$

Answer

- (A) (B) (C) (D)

Paragraph for Question Nos. 41 to 43

In a mixture of H – He⁺ gas (He⁺ is singly ionized He atom), H atoms and He⁺ ions are excited to their respective first excited states. Subsequently, H atoms transfer their total excitation energy to He⁺ ions (by collisions). Assume that the Bohr model of atom is exactly valid.

41. The quantum number n of the state finally populated in He⁺ ions is

- (A) 2 (B) 3 (C) 4 (D) 5

Answer

- (A) (B) (C) (D)

42. The wavelength of light emitted in the visible region by He⁺ ions after collisions with H atoms is

- (A) 6.5×10^{-7} m (B) 5.6×10^{-7} m
(C) 4.8×10^{-7} m (D) 4.0×10^{-7} m

Answer

- (A) (B) (C) (D)

43. The ratio of the kinetic energy of the $n = 2$ electron for the H atom to that of He⁺ ion is

- (A) $\frac{1}{4}$ (B) $\frac{1}{2}$ (C) 1 (D) 2

Answer

- (A) (B) (C) (D)

Paragraph for Question Nos. 44 to 46

A small block of mass M moves on a frictionless surface of an inclined plane, as shown in figure. The angle of the incline suddenly changes from 60° to 30° at point B . The block is initially at rest at A . Assume that collisions between the block and the incline are totally inelastic ($g = 10 \text{ m/s}^2$).

Figure :

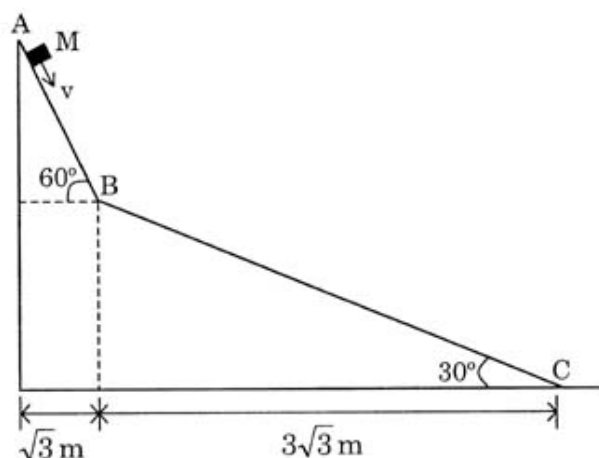

44. The speed of the block at point B immediately after it strikes the second incline is

(A) $\sqrt{60} \text{ m/s}$ (B) $\sqrt{45} \text{ m/s}$ (C) $\sqrt{30} \text{ m/s}$ (D) $\sqrt{15} \text{ m/s}$

Answer

(A) (B) (C) (D)

45. The speed of the block at point C , immediately before it leaves the second incline is

(A) $\sqrt{120} \text{ m/s}$ (B) $\sqrt{105} \text{ m/s}$ (C) $\sqrt{90} \text{ m/s}$ (D) $\sqrt{75} \text{ m/s}$

Answer

(A) (B) (C) (D)

46. If collision between the block and the incline is completely elastic, then the vertical (upward) component of the velocity of the block at point B , immediately after it strikes the second incline is

(A) $\sqrt{30} \text{ m/s}$ (B) $\sqrt{15} \text{ m/s}$ (C) 0 (D) $-\sqrt{15} \text{ m/s}$

Answer

(A) (B) (C) (D)

47. Hyperconjugation involves overlap of the following orbitals

(A) $\sigma - \sigma$ (B) $\sigma - p$ (C) $p - p$ (D) $\pi - \pi$

Answer

(A) (B) (C) (D)

48. The major product of the following reaction is

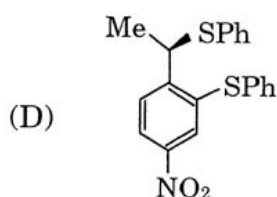
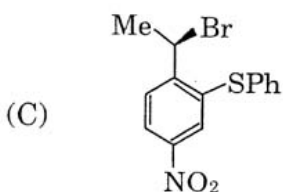
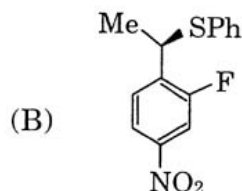
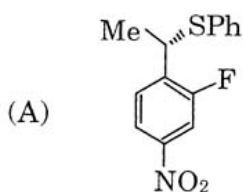
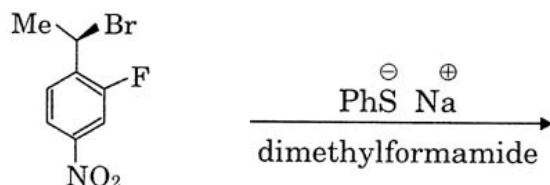

Answer

- (A)
 (B)
 (C)
 (D)

49. Aqueous solution of $\text{Na}_2\text{S}_2\text{O}_3$ on reaction with Cl_2 gives

- (A) $\text{Na}_2\text{S}_4\text{O}_6$ (B) NaHSO_4 (C) NaCl (D) NaOH

Answer

- (A)
 (B)
 (C)
 (D)

50. Native silver metal forms a water soluble complex with a dilute aqueous solution of NaCN in the presence of

- (A) nitrogen (B) oxygen (C) carbon dioxide (D) argon

Answer

- (A)
 (B)
 (C)
 (D)

51. Under the same reaction conditions, initial concentration of $1.386 \text{ mol dm}^{-3}$ of a substance becomes half in 40 seconds and 20 seconds through first order and zero order kinetics, respectively. Ratio $\left(\frac{k_1}{k_0}\right)$ of the rate constants for first order (k_1) and zero order (k_0) of the reactions is

- (A) $0.5 \text{ mol}^{-1} \text{ dm}^3$ (B) 1.0 mol dm^{-3}
 (C) 1.5 mol dm^{-3} (D) $2.0 \text{ mol}^{-1} \text{ dm}^3$

Answer

- (A)
 (B)
 (C)
 (D)

52. 2.5 mL of $\frac{2}{5}$ M weak monoacidic base ($K_b = 1 \times 10^{-12}$ at 25 °C) is titrated with $\frac{2}{15}$ M HCl in water at 25 °C. The concentration of H^+ at equivalence point is ($K_w = 1 \times 10^{-14}$ at 25 °C)

(A) 3.7×10^{-13} M

(B) 3.2×10^{-7} M

(C) 3.2×10^{-2} M

(D) 2.7×10^{-2} M

Answer

- (A) (B) (C) (D)

53. The correct statement(s) about the compound given below is (are)

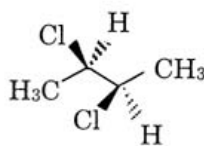

(A) The compound is optically active

(B) The compound possesses centre of symmetry

(C) The compound possesses plane of symmetry

(D) The compound possesses axis of symmetry

Answer

- (A) (B) (C) (D)

54. The correct statement(s) concerning the structures **E**, **F** and **G** is (are)

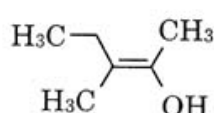
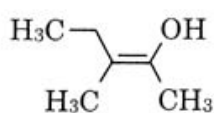
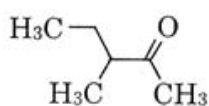

(A) **E**, **F** and **G** are resonance structures

(B) **E**, **F** and **E**, **G** are tautomers

(C) **F** and **G** are geometrical isomers

(D) **F** and **G** are diastereomers

Answer

- (A) (B) (C) (D)

55. A solution of colourless salt **H** on boiling with excess NaOH produces a non-flammable gas. The gas evolution ceases after sometime. Upon addition of Zn dust to the same solution, the gas evolution restarts. The colourless salt(s) **H** is (are)
- (A) NH_4NO_3 (B) NH_4NO_2 (C) NH_4Cl (D) $(\text{NH}_4)_2\text{SO}_4$

Answer

- (A) (B) (C) (D)

56. A gas described by van der Waals equation
- (A) behaves similar to an ideal gas in the limit of large molar volumes
- (B) behaves similar to an ideal gas in the limit of large pressures
- (C) is characterised by van der Waals coefficients that are dependent on the identity of the gas but are independent of the temperature
- (D) has the pressure that is lower than the pressure exerted by the same gas behaving ideally

Answer

- (A) (B) (C) (D)

OR

- (A) (B) (C) (D)

57. STATEMENT-1 : Bromobenzene upon reaction with Br_2/Fe gives 1,4-dibromobenzene as the major product.

and

STATEMENT-2 : In bromobenzene, the inductive effect of the bromo group is more dominant than the mesomeric effect in directing the incoming electrophile.

- (A) STATEMENT-1 is True, STATEMENT-2 is True; STATEMENT-2 is a correct explanation for STATEMENT-1
- (B) STATEMENT-1 is True, STATEMENT-2 is True; STATEMENT-2 is NOT a correct explanation for STATEMENT-1
- (C) STATEMENT-1 is True, STATEMENT-2 is False
- (D) STATEMENT-1 is False, STATEMENT-2 is True

Answer

- (A) (B) (C) (D)

58. STATEMENT-1 : Pb^{4+} compounds are stronger oxidizing agents than Sn^{4+} compounds.
and
STATEMENT-2 : The higher oxidation states for the group 14 elements are more stable for the heavier members of the group due to 'inert pair effect'.
- (A) STATEMENT-1 is True, STATEMENT-2 is True; STATEMENT-2 is a correct explanation for STATEMENT-1
(B) STATEMENT-1 is True, STATEMENT-2 is True; STATEMENT-2 is **NOT** a correct explanation for STATEMENT-1
(C) STATEMENT-1 is True, STATEMENT-2 is False
(D) STATEMENT-1 is False, STATEMENT-2 is True

Answer

- (A) (B) (C) (D)

59. STATEMENT-1 : The plot of atomic number (y-axis) versus number of neutrons (x-axis) for stable nuclei shows a curvature towards x-axis from the line of 45° slope as the atomic number is increased.
and
STATEMENT-2 : Proton-proton electrostatic repulsions begin to overcome attractive forces involving protons and neutrons in heavier nuclides.
- (A) STATEMENT-1 is True, STATEMENT-2 is True; STATEMENT-2 is a correct explanation for STATEMENT-1
(B) STATEMENT-1 is True, STATEMENT-2 is True; STATEMENT-2 is **NOT** a correct explanation for STATEMENT-1
(C) STATEMENT-1 is True, STATEMENT-2 is False
(D) STATEMENT-1 is False, STATEMENT-2 is True

Answer

- (A) (B) (C) (D)

60. STATEMENT-1 : For every chemical reaction at equilibrium, standard Gibbs energy of reaction is zero.
and
STATEMENT-2 : At constant temperature and pressure, chemical reactions are spontaneous in the direction of decreasing Gibbs energy.
- (A) STATEMENT-1 is True, STATEMENT-2 is True; STATEMENT-2 is a correct explanation for STATEMENT-1
(B) STATEMENT-1 is True, STATEMENT-2 is True; STATEMENT-2 is **NOT** a correct explanation for STATEMENT-1
(C) STATEMENT-1 is True, STATEMENT-2 is False
(D) STATEMENT-1 is False, STATEMENT-2 is True

Answer

- (A) (B) (C) (D)

Paragraph for Question Nos. 61 to 63

In the following reaction sequence, products **I**, **J** and **L** are formed. **K** represents a reagent.

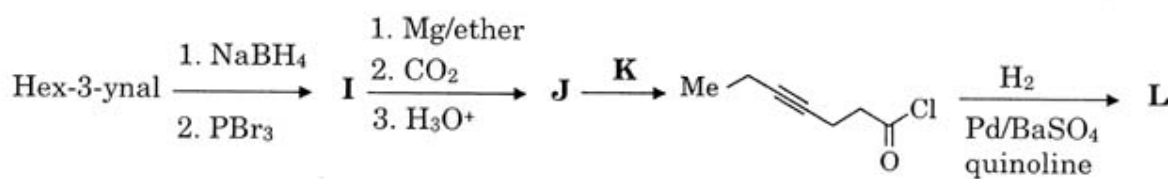

61. The structure of the product **I** is

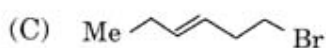
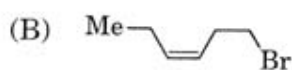

Answer

- (A) (B) (C) (D)

62. The structures of compounds **J** and **K**, respectively, are

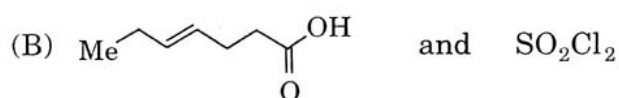
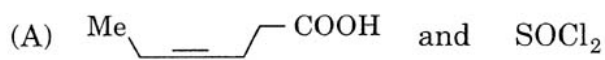

Answer

- (A) (B) (C) (D)

63. The structure of product **L** is

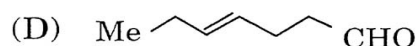
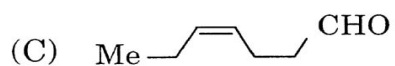
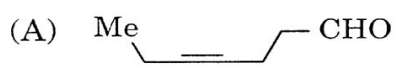

Answer

- (A) (B) (C) (D)

Paragraph for Question Nos. 64 to 66

There are some deposits of nitrates and phosphates in earth's crust. Nitrates are more soluble in water. Nitrates are difficult to reduce under the laboratory conditions but microbes do it easily. Ammonia forms large number of complexes with transition metal ions. Hybridization easily explains the ease of sigma donation capability of NH_3 and PH_3 . Phosphine is a flammable gas and is prepared from white phosphorous.

64. Among the following, the correct statement is

- (A) Phosphates have no biological significance in humans
(B) Between nitrates and phosphates, phosphates are less abundant in earth's crust
(C) Between nitrates and phosphates, nitrates are less abundant in earth's crust
(D) Oxidation of nitrates is possible in soil

Answer

- (A) (B) (C) (D)

65. Among the following, the correct statement is

- (A) Between NH_3 and PH_3 , NH_3 is a better electron donor because the lone pair of electrons occupies spherical 's' orbital and is less directional
(B) Between NH_3 and PH_3 , PH_3 is a better electron donor because the lone pair of electrons occupies sp^3 orbital and is more directional
(C) Between NH_3 and PH_3 , NH_3 is a better electron donor because the lone pair of electrons occupies sp^3 orbital and is more directional
(D) Between NH_3 and PH_3 , PH_3 is a better electron donor because the lone pair of electrons occupies spherical 's' orbital and is less directional

Answer

- (A) (B) (C) (D)

66. White phosphorus on reaction with NaOH gives PH_3 as one of the products. This is a
- (A) dimerization reaction (B) disproportionation reaction
 (C) condensation reaction (D) precipitation reaction

Answer
 (A) (B) (C) (D)

Paragraph for Question Nos. 67 to 69

Properties such as boiling point, freezing point and vapour pressure of a pure solvent change when solute molecules are added to get homogeneous solution. These are called colligative properties. Applications of colligative properties are very useful in day-to-day life. One of its examples is the use of ethylene glycol and water mixture as anti-freezing liquid in the radiator of automobiles

A solution **M** is prepared by mixing ethanol and water. The mole fraction of ethanol in the mixture is 0.9

- Given :
- Freezing point depression constant of water (K_f^{water}) = $1.86 \text{ K kg mol}^{-1}$
 - Freezing point depression constant of ethanol (K_f^{ethanol}) = $2.0 \text{ K kg mol}^{-1}$
 - Boiling point elevation constant of water (K_b^{water}) = $0.52 \text{ K kg mol}^{-1}$
 - Boiling point elevation constant of ethanol (K_b^{ethanol}) = $1.2 \text{ K kg mol}^{-1}$
 - Standard freezing point of water = 273 K
 - Standard freezing point of ethanol = 155.7 K
 - Standard boiling point of water = 373 K
 - Standard boiling point of ethanol = 351.5 K
 - Vapour pressure of pure water = 32.8 mm Hg
 - Vapour pressure of pure ethanol = 40 mm Hg
 - Molecular weight of water = 18 g mol^{-1}
 - Molecular weight of ethanol = 46 g mol^{-1}

In answering the following questions, consider the solutions to be ideal dilute solutions and solutes to be non-volatile and non-dissociative.

67. The freezing point of the solution **M** is
- (A) 268.7 K (B) 268.5 K (C) 234.2 K (D) 150.9 K

Answer
 (A) (B) (C) (D)

68. The vapour pressure of the solution **M** is

(A) 39.3 mm Hg

(B) 36.0 mm Hg

(C) 29.5 mm Hg

(D) 28.8 mm Hg

Answer

- (A) (B) (C) (D)

69. Water is added to the solution **M** such that the mole fraction of water in the solution becomes 0.9. The boiling point of this solution is

(A) 380.4 K

(B) 376.2 K

(C) 375.5 K

(D) 354.7 K

Answer

- (A) (B) (C) (D)